

ASTRAL POOL 

OWNER'S MANUAL

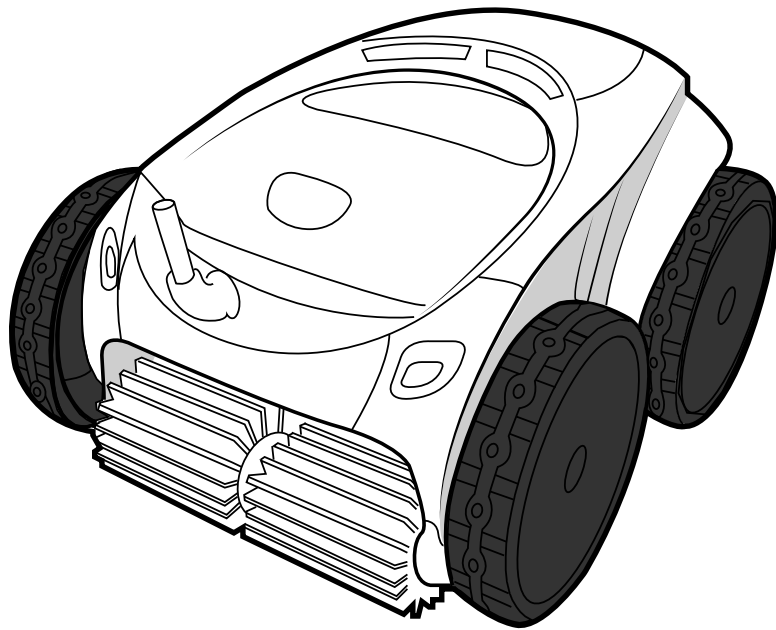

VIRON™ QT 1000 ROBOTIC POOL CLEANER

 **iAquaLink™**
CONTROL

TYPE EC15--

WARNING

FOR YOUR SAFETY - For anything other than the routine cleaning and maintenance described in this manual, this product must be serviced by a pool technician who is licensed and qualified in pool equipment by the jurisdiction in which the product will be installed where such state or local requirements exist. In the event no such state or local requirement exists, the maintainer must be a professional with sufficient experience in pool equipment installation and maintenance so that all of the instructions in this manual can be followed exactly. Improper installation and/or operation will void the warranty.

TABLE OF CONTENTS

Section 1. Important Safety Instructions.....	4	Section 6. iAquaLink™ Control.....	12
Section 2. Cleaner Specifications	5	6.1 iAquaLink™ Control Home Screen	12
Section 3. Assembly.....	6	6.2 Start / Stop Cleaning and Adjust Cleaning Time	12
3.1 Contents	6	6.3 Set Cleaning Mode	13
3.2 Assemble the Transport Caddy	6	6.4 Remote Control.....	13
3.3 Attach the Control Unit to the Caddy	7	6.5 Elevate System	13
3.4 Connect to a Power Source	8	6.6 Program / Cancel Cleaning Schedules.....	13
Section 4. General Cleaner Operation.....	9	6.7 LED Lights	13
4.1 Install and Submerge the Cleaner.....	9	6.8 In-App Error Messages and Troubleshooting	14
4.2 Control Unit.....	10	6.9 System Settings	14
4.3 Start / Stop Cleaning and Adjust Cleaning Time	11	Section 7. Storage & Maintenance.....	14
4.4 Elevate System	11	7.1 Cord Tangling	14
Section 5. Installing iAquaLink™	11	7.2 Clean the Filter Canister.....	15
5.1 Download the App	11	7.3 Store the Cleaner When Not in Use	16
5.2 Sign Up and Log In	12	7.4 Replacing Wear Parts	16
5.3 Configure the System	12	7.5 Replacing Tyres	18
		7.6 General Troubleshooting.....	20
		7.7 Dismissing an Error Code	21
		7.8 iAquaLink™ Troubleshooting	22
		7.9 Conformity	23

Section 1. Important Safety Instructions

READ AND FOLLOW ALL INSTRUCTIONS

Congratulations on purchasing the AstralPool Robotic Cleaner. Please read through the entire manual before installing your new robotic pool cleaner. Your cleaner must be installed and operated as specified.

⚠ WARNING

Failure to comply with the following warnings can increase risk of fire or electrocution which can result in property damage and serious injury, including loss of life.

PREVENT ELECTRICAL SHOCK

To reduce risk of electrical shock:

- The cleaner is to be installed in accordance with the relevant requirements of the Australian wiring rules AS/NZS 3000. Also refer to the installation instructions relating to the swimming pool equipment for which the cleaner will be an integral part. The cleaner is to be supplied through a Residual Current Device (RCD) with a rated residual operating current of 30mA.
- Do not enter pool while the robotic cleaner is in water.
- Do not bury cord. Locate cord so as to prevent it from being damaged by lawn mowers, hedge trimmers and other equipment.
- To reduce the risk of electrical shock, do not use the robotic cleaner or control unit if the cord is worn or damaged. Contact AstraPool Consumer Care 1300 186 875 immediately for proper servicing and replacement of the damaged cord.
- Double insulation—For continued protection against possible electric shock, use only identical replacement parts when servicing. Do not attempt repair of the robotic cleaner, control unit, power cord, or floating cable.
- Use only the power supply provided with the product.
- NEVER OPEN CONTROL UNIT.
- DO NOT USE AN EXTENSION CORD TO CONNECT THE UNIT TO ELECTRIC SUPPLY; PROVIDE A PROPERLY LOCATED APPROVED ELECTRICAL OUTLET. THE CONTROL UNIT SHOULD BE PLACED NEAR THE APPROVED RECEPTACLE BOX.

PREVENT CHILD INJURY AND DROWNING

- To reduce the risk of injury, do not permit children or persons with reduced physical, sensory or mental capabilities, or lack of experience and knowledge to operate this product.
- Do not let anyone, especially small children, sit, step, lean, or climb on any equipment installed as part of your pool's operational system.

⚠ CAUTION

Failure to comply with the following warnings could cause damage to pool equipment or personal injury.

- The robotic cleaner must be installed and operated as specified.
- This product is intended for use with permanently-installed pools. Do not use with storable pools. A permanently-installed pool is constructed in or on the ground or in a building such that it cannot be readily disassembled for storage. A storable pool is constructed so that it is capable of being readily disassembled for storage and reassembled to its original integrity.
- Clean the filter canister in the VIRON™ QT1000 cleaner after each use.
- Do not use the product in your pool if the water temperature is above 35° C (95° F) or below 13° C (55° F).

USE OF THE ROBOTIC CLEANER IN A VINYL LINER POOL

Certain vinyl liner patterns are particularly susceptible to rapid surface wear or pattern removal caused by objects coming into contact with the vinyl surface, including pool brushes, pool toys, floats, fountains, chlorine dispensers, and automatic pool cleaners. Some vinyl liner patterns can be seriously scratched or abraded simply by rubbing the surface with a pool brush. Ink from the pattern can also rub off during the installation process or when it comes into contact with objects in the pool. AstralPool Group Australia Pty Ltd is not responsible for, and the Limited Warranty does not cover, pattern removal, abrasion or markings on vinyl liners.

SAVE THESE INSTRUCTIONS

Section 2. Cleaner Specifications

The general specifications for the cleaner are as follows:

Control box supply voltage 	220-240 VAC, 50 Hz; short circuit-proof safety isolating type
Supply voltage	30 V DC
Installed load	150 W max
Cable length	18 M
Cleaner size (WxDxH)	43 x 48 x 27 cm
Weight of Cleaner	9.5 kg
Packed weight	19 kg
Filtration	All-purpose filter canister
Cycle lengths	Variable programming.

The cleaner is a double-insulated product. A double-insulated electrical appliance is one which has been designed in such a way that it does not require a safety connection to ground. The basic requirement for double-insulation is that no single failure can result in dangerous voltage becoming exposed so that it might cause an electric shock and that this is achieved without relying on an earthed (grounded) metal casing. This is achieved by having two (2) layers of insulating material surrounding live parts or by using reinforced insulation. Therefore, devices having double-insulated construction, such as this cleaner, do not utilize a grounded (three-prong) cord/plug.

Section 3. Assembly

3.1 Contents

The packaging should contain the following items:

- Cleaner and floating cable
- Control unit
- Manual, Quick Start Guide, and Warranty Card
- Transport and storage caddy components:
 - a. handle frame
 - b. support blocks (x 2)
 - c. wheels (x 2)
 - d. wheel locking clips (x 2)
 - e. wheel axle / hubcap (x 2)
 - f. base unit
 - g. cleaner hook
 - h. caddy handle

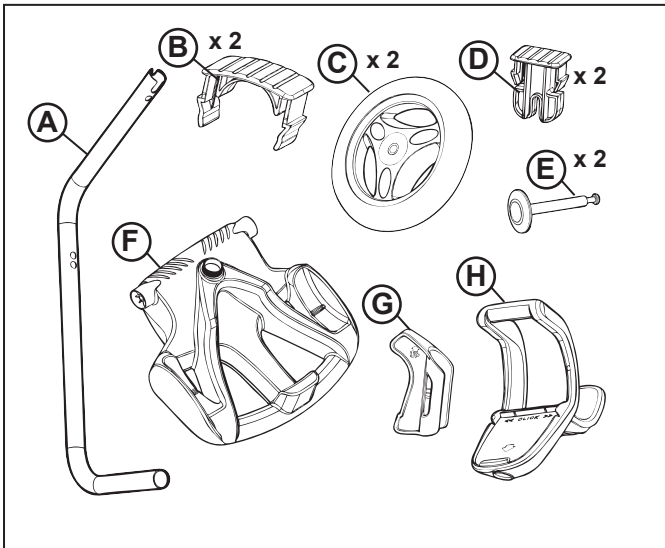

Figure 1. Transport Caddy Assembly Components

When unpacking the cleaner and its components:

- Check to make sure each component is in the box.
- Check cleaner and components for damage during transport.
- If there are any missing parts or damage, contact Technical Support at 1300 186 875

3.2 Assemble the Transport Caddy

1. Unscrew the handnut from the base.

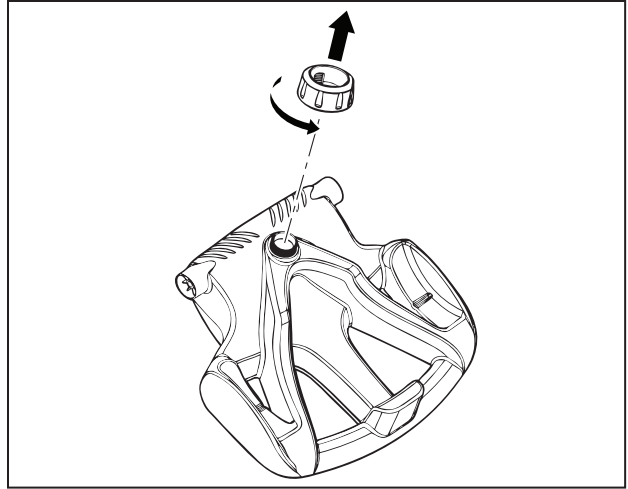

Figure 2. Remove Handnut from Base Unit

2. Insert the metal handle frame tubing into the base with notch end at the top, then rotate so the bends are away from you.
3. Push base down so the metal handle frame is seated in the recess on the underside of the base.

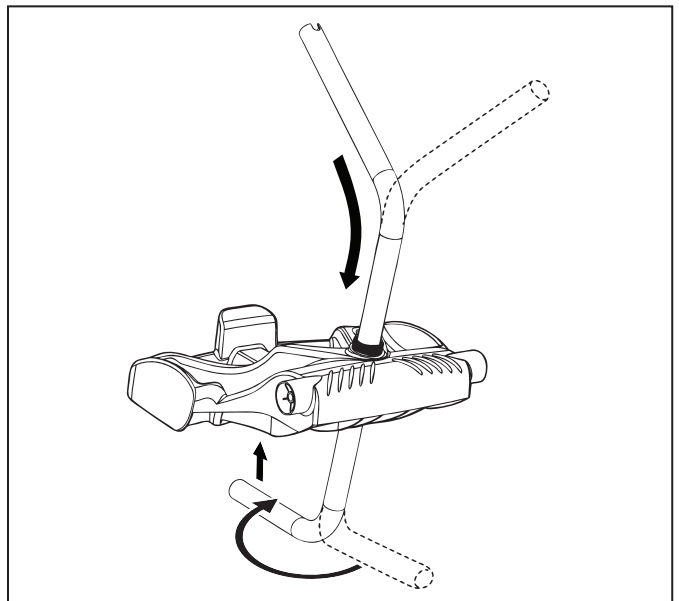

Figure 3. Connect Metal Frame to Base Unit

4. Slide the handnut over the tube and twist to tighten onto base unit.

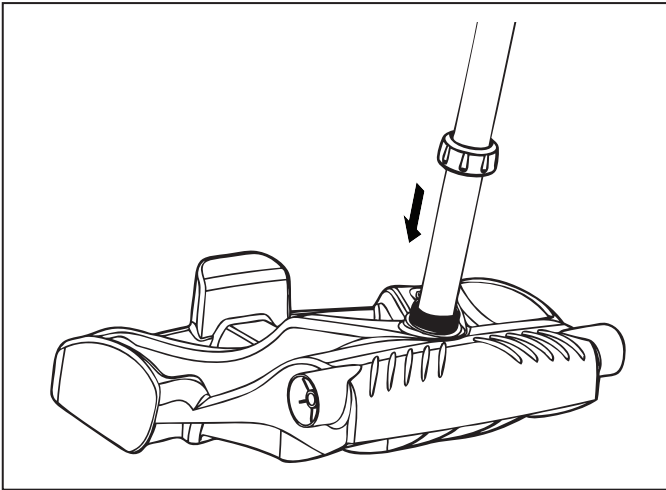

Figure 4. Twist Handnut to Secure Frame

5. Snap two (2) support blocks into place.
6. Slide axle and hubcap piece through center of wheel and attach to base unit. Snap locking clip into place to secure wheel. Repeat to attach both wheels.

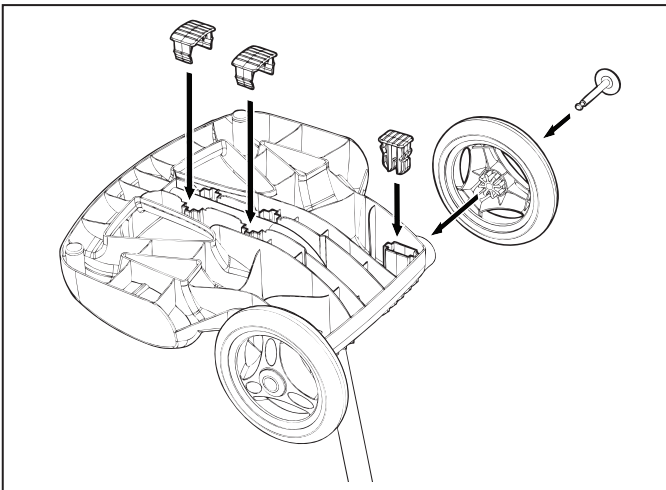

Figure 5. Snap in Support Blocks and Attach Wheels

7. Slide the control unit base / caddy handle attachment down over the metal tubing until it snaps into place.

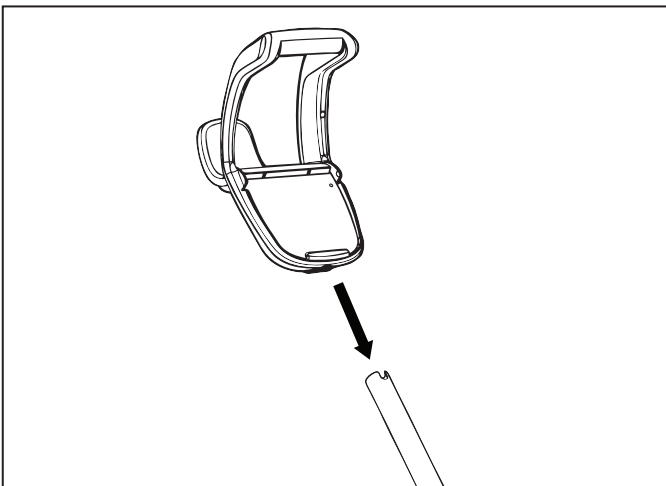

Figure 6. Attach Caddy Handle

8. Align cleaner hook pins with the top holes in the handle tube and snap into place.

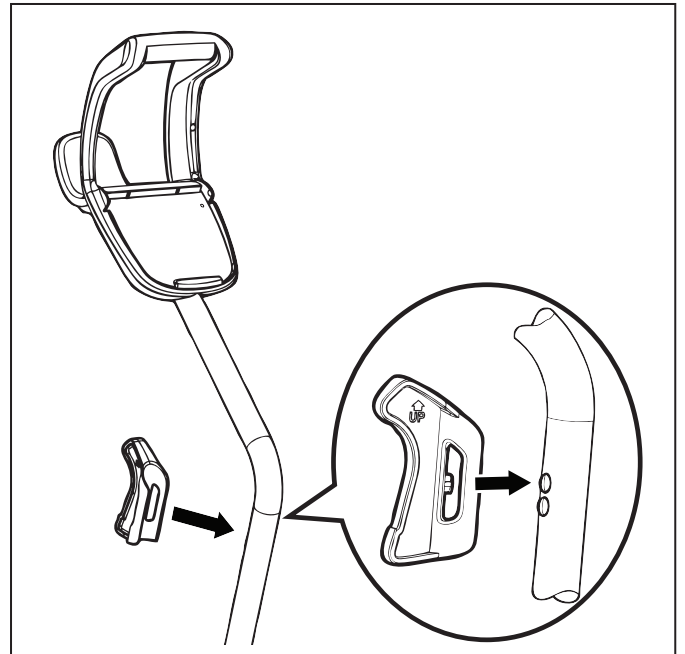

Figure 7. Snap Cleaner Hook into Place

3.3 Attach the Control Unit to the Caddy

1. Align the bottom of the control unit with the notch at bottom of the control unit hook on the caddy.

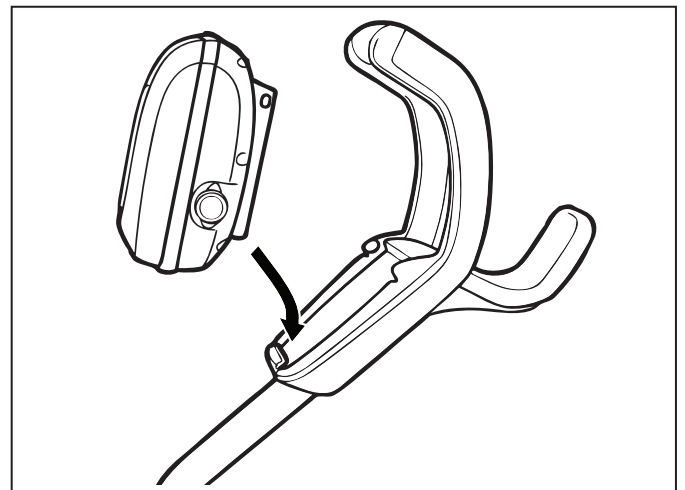

Figure 8. Align Control Unit with Caddy Hook

2. Press control unit onto the caddy hook until it snaps and locks into position.

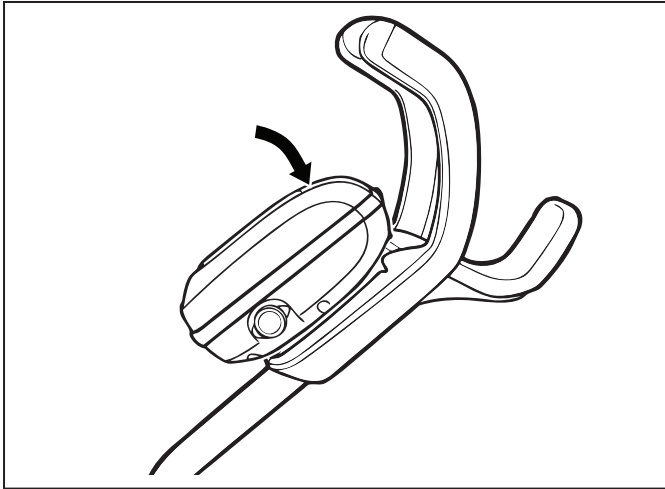

Figure 9. Attach the Control Unit onto Caddy

3.4 Connect to a Power Source

⚠ WARNING

Failure to comply with the following warnings can increase risk of fire or electrocution which can result in property damage and serious injury, including loss of life.

PREVENT ELECTRICAL SHOCK

- Keep the control unit at least 3.5 m from the edge of the pool.
- The cleaner is to be installed in accordance with the relevant requirements of the Australian wiring rules AS/NZS 3000. Also refer to the installation instructions relating to the swimming pool equipment for which the cleaner will be an integral part. The cleaner is to be supplied through a Residual Current Device (RCD) with a rated residual operating current of 30mA.
- Do not use an extension cord to connect the control unit.
- Do not allow anyone to swim while the cleaner is in the pool.
- The control unit is water-resistant, not water-proof. In order to prevent electrocution, never submerge the control unit or leave exposed to inclement weather.

1. Unscrew the protective cap for the floating cable from the side of the control unit by turning counter-clockwise.
2. Grip the notched end of the floating power cable, insert into the control unit, and turn clockwise to tighten.

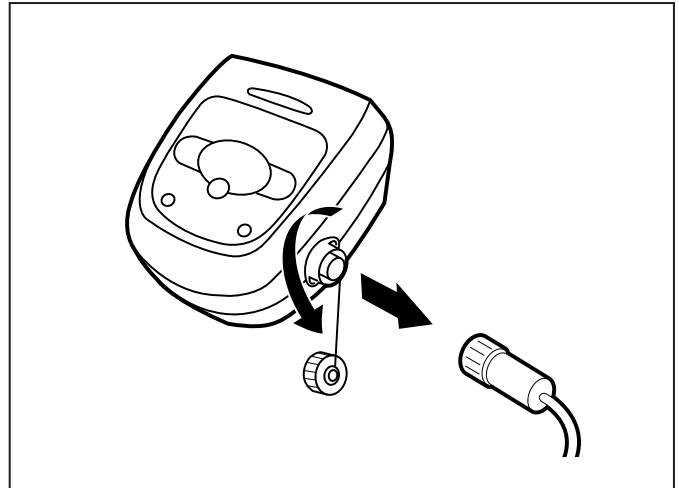
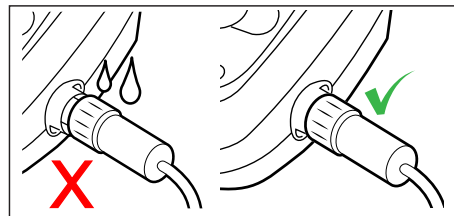

Figure 10. Remove Protective Cap and Connect Power Cable

NOTE: To avoid damaging the power cable, do not try to twist the entire cable housing. (See below)



NOTE: To avoid exposing the power cable connector pins to water, be sure the connector is screwed in all the way and there is no gap. (See below)



Section 4. General Cleaner Operation

⚠ CAUTION

To prevent damage to the cleaner, be sure to adhere to the following guidelines:

- Remove the cleaner from the pool after each cleaning cycle is completed.
- Store on the caddy out of direct sunlight or inclement weather.
- Never remove the cleaner from the pool by the floating cable. Always use the Elevate System to remove cleaner from the pool.
- Take additional care when lifting the cleaner out of the pool. It becomes heavier when filled with water.
- Always remove the cleaner from pool when super chlorinating or adding acid.
- Do not handle cleaner while it is in operation

IMPORTANT

- Always make sure the cleaner head is fully submerged before you begin operation.
- Clean the filter canister after each cleaning cycle.
- Do not leave your cleaner in the pool on a permanent basis.
- At the end of each cleaning cycle, remove the cleaner from the pool.
- Start at the cleaner head and untangle any coils in the cable before storing the cleaner.

The VIRON QT1000 robotic cleaner includes a safety feature that automatically stops the cleaner if it is powered on but not submerged in water. For pools equipped with a beach area, this safety feature is programmed to drive the cleaner in reverse and back into the pool when the impeller is out of the water.

AstralPool recommends not exceeding 3 cleaning cycles per week.

4.1 Install and Submerge the Cleaner

1. With the control box plugged into a power outlet, spread the floating cable across the pool deck until you reach the middle of the pool length.
2. At the center point, submerge the cleaner in the pool and hold in the vertical position to release any air trapped inside.

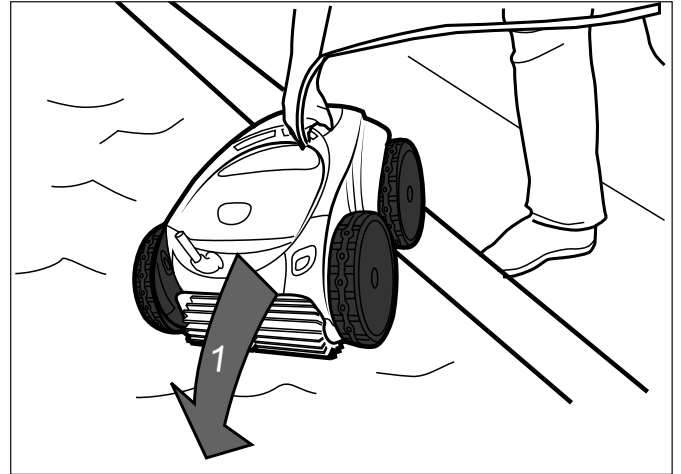

Figure 11. Submerge Cleaner Vertically

3. Ensure the unit sinks to the bottom of the pool and does not float.

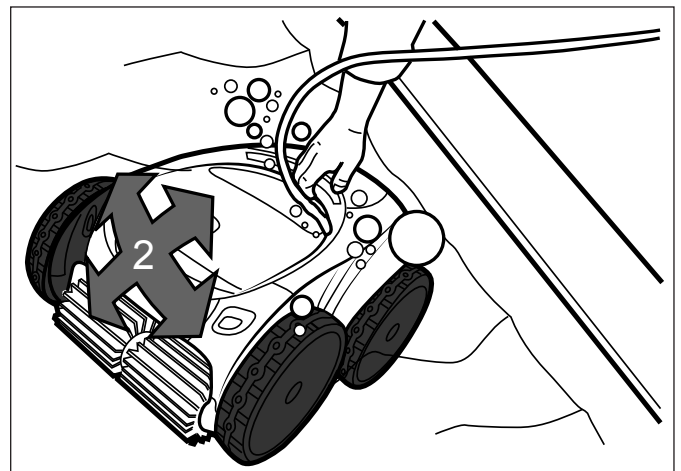

Figure 12. Sink Cleaner to the Bottom of the Pool

4. Place only enough floating cable in the water to reach the farthest end of your pool from the central point. Spread out the floating cable ensuring there are no kinks or coils in the cable.

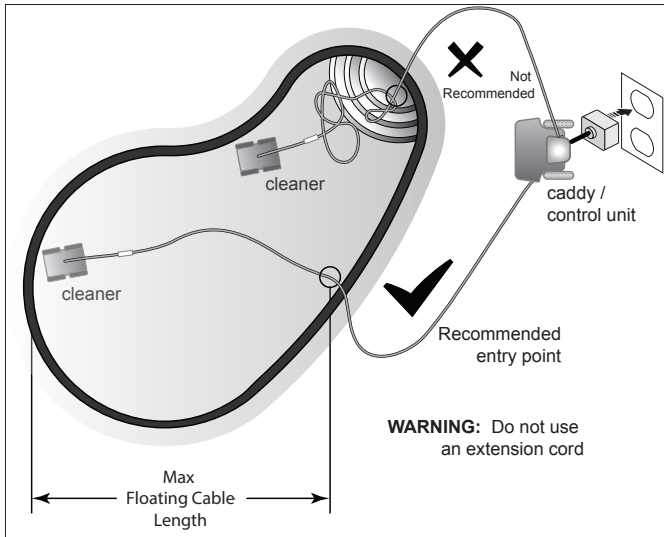

Figure 13. Pool Entry Point for Optimal Patterning











4.2 Control Unit

The control unit can be used to initiate basic cleaning features and to connect the device to home Wi-Fi. For more information on connecting your cleaner to Wi-Fi, see Section 5, Installing iAquaLink™



Figure 14. Control Unit and Button Functions

Button Functions

-  Cleaner is receiving power
-  Start/Stop cleaning
-  Select cleaning mode:
 -  Quick Clean (1h 15 min) Floor only
 -  SMART Cycle (Calculate custom clean duration) Floor, Wall, Waterline
 -  Deep Clean (2h 45 min) Floor, Walls, Waterline, High Intensity
-  Dirty canister indicator
-  Elevate System. Remove cleaner from the pool
-  Increase or decrease cleaning time in 15 minute increments
-  Initiate connection and set up iAquaLink™ control
-  Bluetooth connection status:
 - BLINKING* - searching for signal
 - SOLID* - paired with phone

4.3 Start / Stop Cleaning and Adjust Cleaning Time

The factory default cleaning mode is SMART Cycle (Floor, Wall, Waterline).

Cycle calculates a customized cleaning time optimized for your pool. On the first run of SMART Cycle, the control box counts up from zero as it calculates the optimized cleaning time.

On periodic SMART Cycle cleaning, the control box will count down from the optimized cleaning time.

To recalculate the SMART Cycle setting, press and hold the  button for 5 seconds.

Use  to change cleaning surface setting. Toggle between: ()

 Quick Clean
(1h 15 min) Floor only

 SMART Cycle
(calculates custom cleaning duration)
Floor, Wall, Waterline

 Deep Clean
(2h 45 min)
Floor, Walls, Waterline, High Intensity

With the cleaner submerged in the water, press  to begin operation.

Press again to interrupt and cancel an in-progress cleaning cycle.

NOTE: The control box automatically goes into standby mode after 5 minutes and the display screen turns off. Press any key to exit standby mode and view remaining cycle time. Cleaner will continue to function in standby mode.

Press +/- buttons to increase or decrease cleaning time in 15-minute increments.

4.4 Elevate System

The Elevate System is designed to assist in retrieving the robot from the pool. The Elevate System can be activated at any time during or after a cleaning cycle.

1. Press  to begin the automated procedure. The screen displays **LIFE** when the Elevate System is in operation.

NOTE: To stop the procedure at any time, press and release the button again.

2. Next, Press and HOLD  to rotate the cleaner.
3. Once the cleaner is facing the wall of your choice for

retrieval, release the button.

4. Cleaner will drive forward and up the wall it is facing. It will wait at the water line to be retrieved.
5. When in reach, remove the cleaner from the pool using the handle. The cleaner will quickly expel water to allow for lighter, easier removal.

NOTE: Never remove the cleaner from the pool by the floating cable.

Section 5. Installing iAquaLink™



The iAquaLink app is available for download from the App Store or Google Play.

With iAquaLink Control, you can connect to your robotic cleaner from anywhere, anytime to access many functions and troubleshooting advice.

Before you begin installation, make sure you have the following:

- Robotic Cleaner submerged in the pool.
- Control Box connected and plugged into a GFCI outlet.
- Smart device (phone or tablet) with Wi-Fi and Bluetooth enabled
- Wi-Fi router with sufficient signal strength at the Control Box
- **IMPORTANT:** Have your Wi-Fi network password available.

5.1 Download the App

Install or update the **iAquaLink** app from the App Store or Google Play.



Once the download is complete, select the **iAquaLink icon** on your smart device to open the app.

5.2 Sign Up and Log In

Click **Sign Up** to create a new user account. Or, if you previously set up an iAquaLink account, click **Log In** to access your systems.

Complete all required fields in the Account Set Up page and agree to the Terms and Conditions.

5.3 Configure the System

1. On the My Systems page, click + in the upper right-hand corner to add a system.
2. Choose "Robotic Cleaner" from the list and choose your model type.
3. On the Control Box, press .
4. Bluetooth light  indicates status:
5. BLINKING - searching for signal
6. SOLID - paired with phone
7. Follow on-screen prompts to add your cleaner and connect to your home router.
8. Wi-Fi light  indicates status:
9. BLINKING - connected to router
10. SOLID - connected to the internet

NOTE: The searching screen may take a few minutes to find your router. If you receive an error you may have a weak router signal at the location of your control box OR you may have entered an incorrect Wi-Fi password. In the case of a weak router signal, consider installing a Wi-Fi extender to boost your signal strength. (See iAquaLink Troubleshooting section.)

NOTE: **Send Invite Code** - you can only send invite codes if you are set up as the Primary User. Sending an invite codes to friends and family will allow them to access the cleaner app functions and programming. If you choose to Skip this step, the Primary User can always send Invite Codes later.

Section 6. iAquaLink™ Control

Once you have downloaded the iAquaLink app and connected the device to Wi-Fi, the iAquaLink app allows for robotic cleaner control from anywhere, anytime. Functions vary within the iAqualink app depending on which cleaner model you have.



⚠ WARNING

Do not enter pool while the robotic cleaner is in water.

6.1 iAquaLink™ Control Home Screen

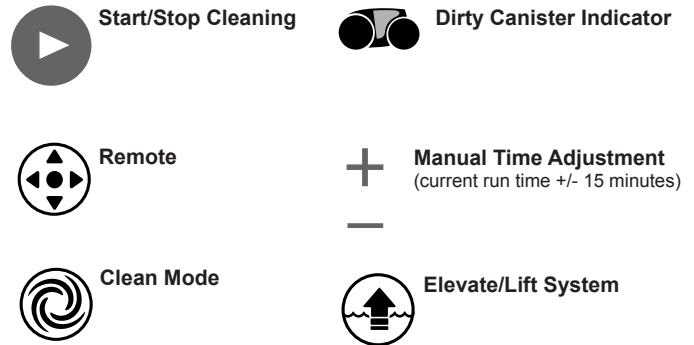

*App function and design is subject to change.



6.2 Start / Stop Cleaning and Adjust Cleaning Time

The factory default cleaning surface setting is SMART Cycle (Floor, Wall, Waterline).

SMART Cycle calculates a customized cleaning time optimized for your pool. On the first run of SMART Cycle, the app counts up as it calculates the optimized cleaning time.

On periodic SMART Cycle cleaning, the app will count down from the optimized cleaning time.

NOTE: To recalculate SMART Cycle, go to the Set Cleaning Mode after the initial calculation.

1. From the Home screen or the Control Box, press the Start/Stop button to begin cleaning.  | 
2. The app displays the cycle time in hours and minutes.
3. To increase or decrease the cycle time during cleaning, press the (+) and (-) buttons.
 - Time adjusts up or down in 15 minute increments.
 - Minimum run time is 30 minutes.
 - Maximum run time is 3 hours 30 minutes.
 - The control box displays the same countdown and cycle setting as the app.
4. Press  to interrupt and cancel an in-progress cleaning cycle.

6.3 Set Cleaning Mode

1. From the main screen, select **Cleaning Mode** to view options.
2. Choose from available cleaning modes depending on your cleaner model.
3. In Custom mode (If applicable), select the cleaning surface and cleaning intensity from the on-screen icons.

6.4 Remote Control

Use your mobile device as a remote control.

IMPORTANT: Only use Remote Control when in view of the cleaner.

1. From the main screen, select the **Remote** tab.

NOTE: When in remote control mode, the control box displays 

2. You can direct the cleaner using the remote control to help pick up debris.

NOTE: If you notice significant delays in response time, check your Wi-Fi connection status and signal strength.

6.5 Elevate System

The Elevate System is designed to assist in retrieving the robot from the pool. The Elevate System can be activated at any time during or after a cleaning cycle.

IMPORTANT: Only use the Elevate System when in view of the cleaner.

1. From the main screen, select  **Elevate System** to enter automated procedure.
2. Use the **left** and **right** arrow icons to rotate the cleaner to face the wall of your choice.
3. Press the **Elevate System** icon to drive the cleaner up the wall it is facing. The cleaner will wait at the water line to be retrieved.

NOTE: To stop the procedure at any time, press and release the button again.

4. When in reach, grab the cleaner handle and begin to pull cleaner out of the water. The cleaner will quickly expel water to allow for lighter, easier removal.

NOTE: Never lift the cleaner out of the pool by the floating cable.

6.6 Program / Cancel Cleaning Schedules

It is still recommended to remove and clean the filter canister after every cleaning cycle.

1. Tap the area titled **Next Cleaning** or go to **System Settings**  and choose **Schedules**.
2. To program a schedule, select the **day of the week**.
3. Select a **start time** to begin the cleaning cycle.

NOTE: In the system settings menu you may choose to display the start time in standard or 24-hour format.

4. Select a cleaning mode. Mode selected will determine runtime.
5. Press **OK** to save the schedule or **Delete** to remove permanently.
6. Repeat steps 2-4 to program additional days.

NOTE: It is still recommended to remove and clean the filter canister after every cleaning cycle. Only one programmed cleaning cycle can be scheduled per day.

7. Press **BACK or DONE** to leave the Edit Schedule page and return to the main screen.
8. The next scheduled cleaning cycle will display near the top of the main screen.

6.7 LED Lights

An LED light illuminates the interior area of the body and canister.

The Sensor Nav System™ LED is located on the front of the cleaner. This LED light indicates status, either:

Blinking Blue - Sensing, Scanning and Cleaning

Solid Blue - Cleaning in progress

Blinking Green - Elevate System in use

Solid Green - Remote Control in use

NOTE: LED lights may be difficult to see in sunlight.

6.8 In-App Error Messages and Troubleshooting

If an error occurs, the status bar will show a warning symbol and: "Cleaning Interrupted".

1. Click on the warning symbol to view troubleshooting advice on how to fix the issue.
2. Choose **Clear Error** if you believe you have fixed the problem and want to re-try. Choose **OK** if you want to suspend the cleaner in error mode and work on the troubleshooting fix at a later time.

6.9 System Settings

Access System Settings by pressing the gear icon in the upper right hand corner of the app screen.

Section 7. Storage & Maintenance

⚠ WARNING

To avoid electric shock and other hazards which could result in permanent injury or death, disconnect (unplug) the cleaner from the power source before performing any cleaning and maintenance.

7.1 Cord Tangling

Tangling can occur more frequently when the cleaner is not attended to after each cleaning cycle. The tangle-reducing swivel, in addition to proper installation, general maintenance and the following troubleshooting steps can help to avoid cable challenges.

IMPORTANT

Cleaner power cable may become tangled if correct procedure is not followed after each cleaning cycle.

NOTE: For optimal patterning and reduced tangling, the floating cable should enter the water near the middle of the pool length. Only place enough cable in the water to reach the farthest point in the pool.

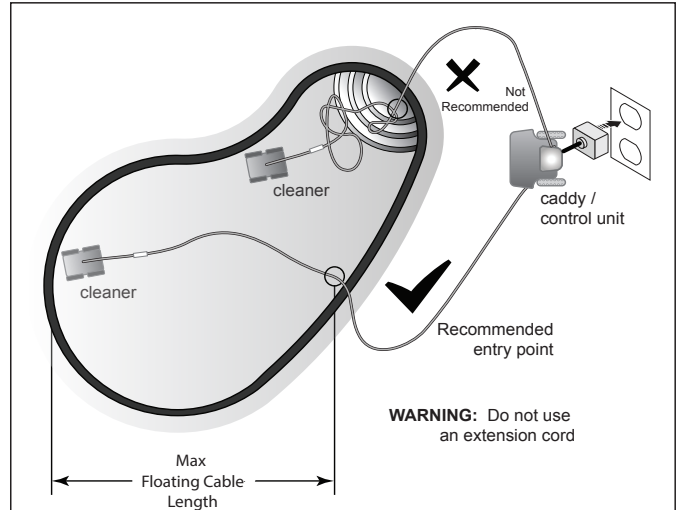

Figure 15. Optimal Entry Point in Pool

1. If tangling occurs, follow these steps:
2. Remove the cleaner from the pool using the Elevate System. When the cleaner is within arm's reach, use the handle to remove from the water. Never remove the from the pool by the floating cable or swivel.
3. Hold the cleaner vertically to drain.

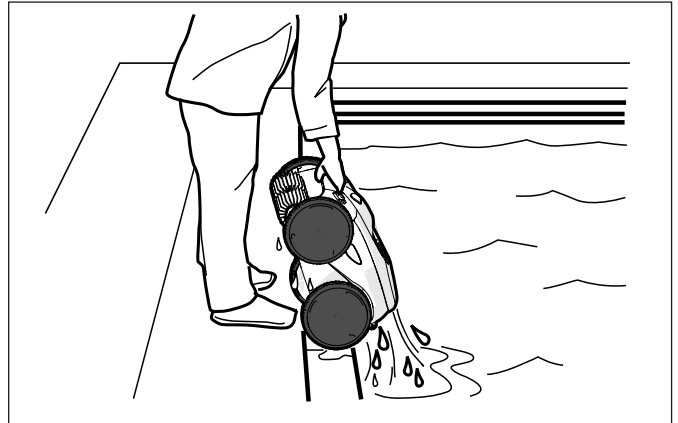

Figure 16. Keep Cleaner Vertical to Drain Water

4. Unplug power to the cleaner at the control box.

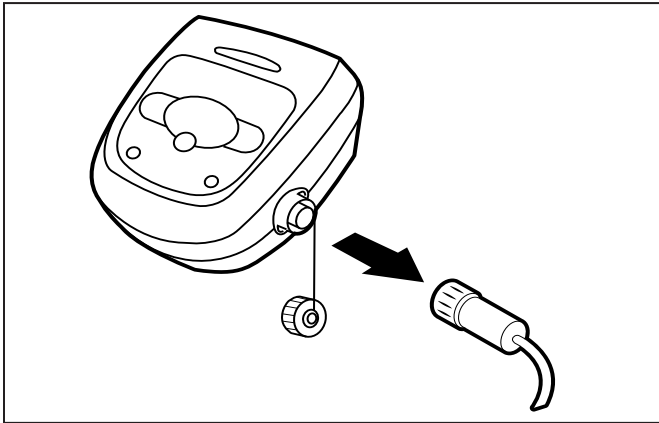

Figure 17. Unplug

5. Remove the cleaner from the pool and untangle all kinks and coils in the power cable. Start at the cleaner head. Lay the cable in the sun to loosen any tangling memory.

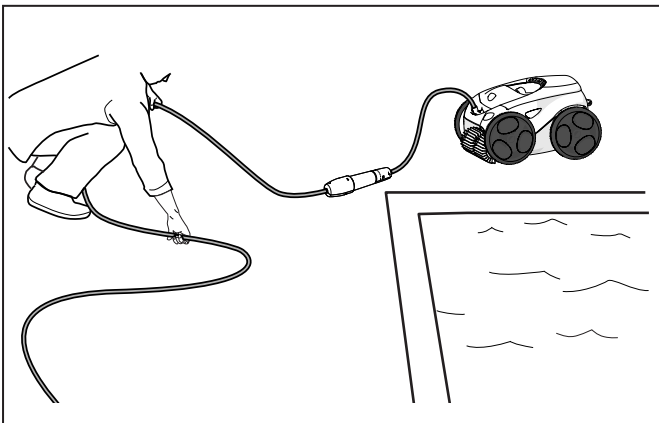

Figure 18. Untangle the Power Cable

7.2 Clean the Filter Canister

The filter canister should be cleaned at the end of each cycle.

1. Remove the cleaner from the water using the Elevate System and let the remaining water drain.
2. Set the unit on four wheels.
3. Push the cover lock (1) and lift the cover (2) until it is secured in the vertical position.

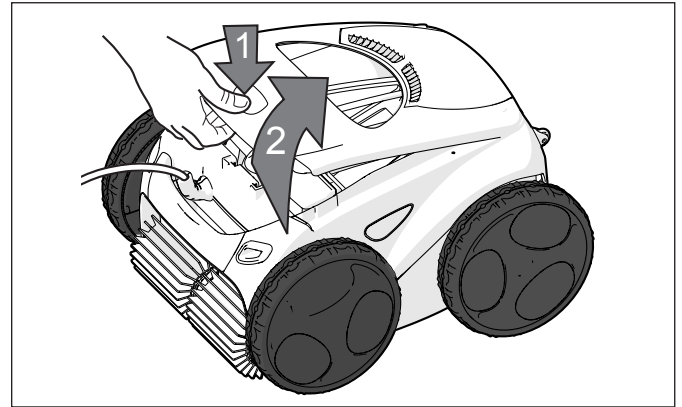

Figure 19. Lift the Cleaner Cover

4. Remove the filter canister assembly from the body (3).

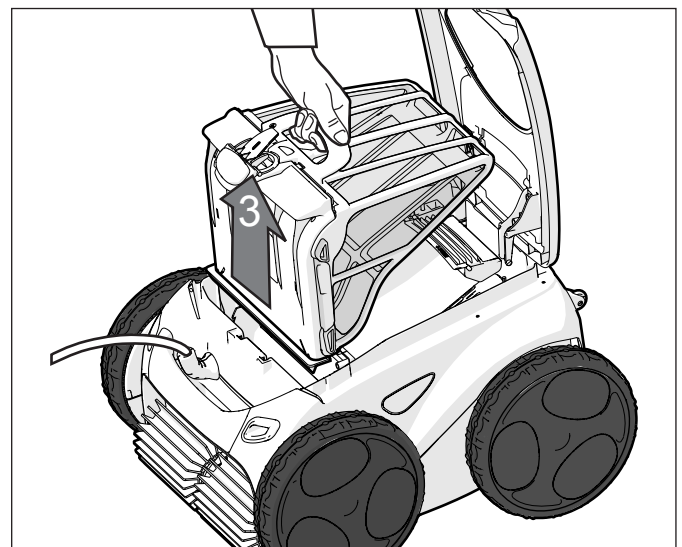

Figure 20. Remove the Filter Canister

5. Push the quick release button on the canister assembly (4) and pull open (5).
6. Separate the filter canister from the filter support (6).

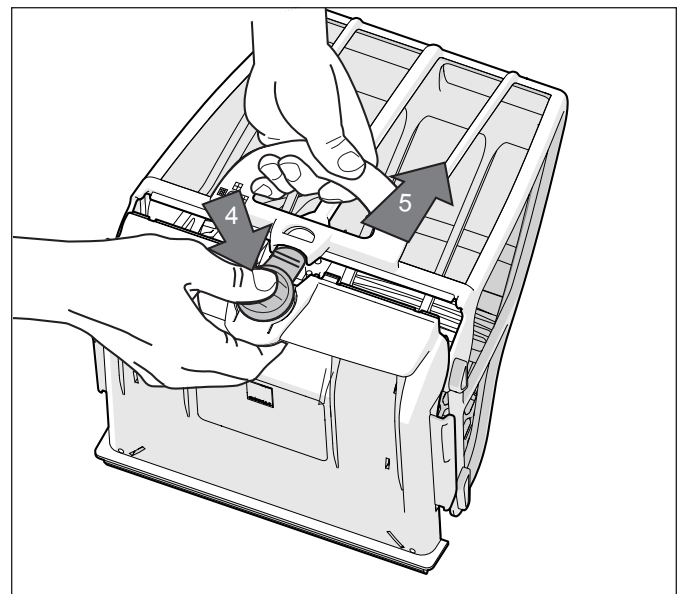

Figure 21. Open Filter Canister Assembly

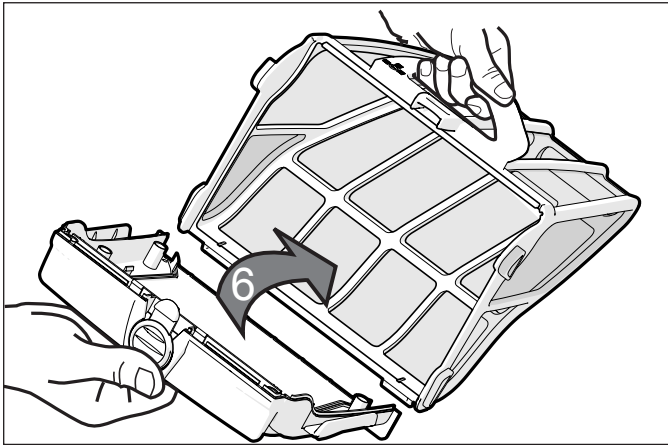

Figure 22. Remove Filter Canister

7. Empty all debris from the filter canister, then rinse the canister, the filter support and the cleaner using a hose.

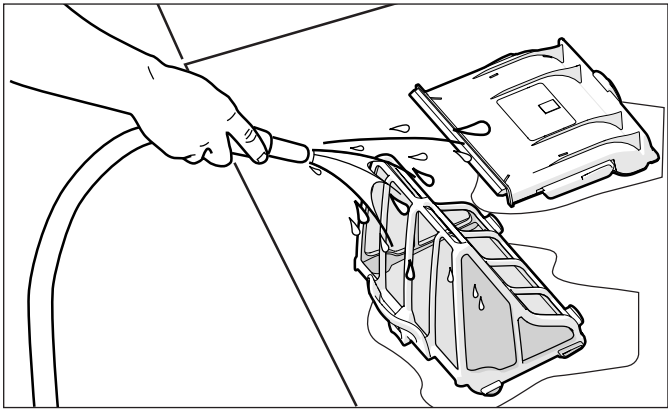

Figure 23. Wash the Filter Canister

NOTE: Periodically, remove the filter canister and clean thoroughly with soapy water and a soft bristle brush.

7.3 Store the Cleaner When Not in Use

The cleaner must be cleaned regularly using slightly soapy clean water. Do not use solvents such as trichlorethylene or its equivalent. Rinse the cleaner generously using clean water. Do not let your cleaner dry in direct sunlight near the pool. The cleaner should be stored on its caddy so that it dries quickly.

1. Disconnect cleaner from the power source.
2. Starting at the cleaner head, remove all coils and tangles from the cable. Lay the cable in the sun to loosen any tangling memory.

3. Place the rear wheels on the caddy and position the cleaner vertically on the caddy base.
4. Disconnect the cable from the control box. Replace the protective cap on the control box.

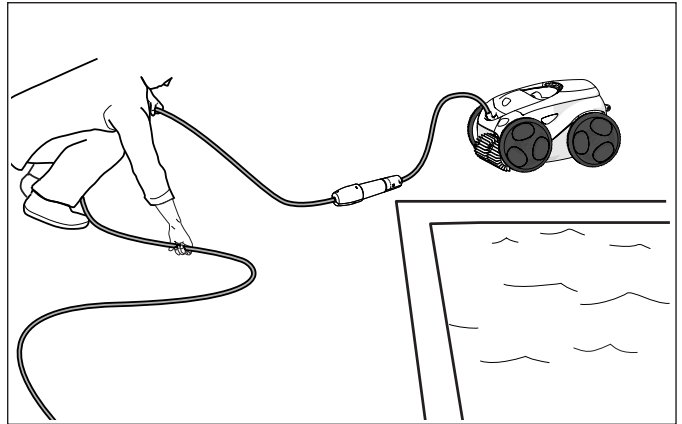

Figure 24. Untangle the Floating cable

5. Loosely coil the power cable starting at the cleaner and moving toward the connection point at control box. Store the cable by wrapping it around the hook located on the front of the caddy.

7.4 Replacing Wear Parts

7.4.1 Replacing Brushes

The cleaner is fitted with PVC brushes with a "wear" indicator.

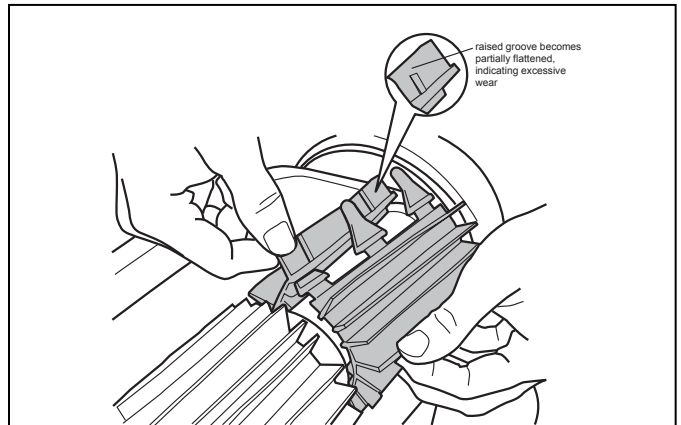

Figure 25. Worn Brush Indicator

To maintain cleaner performance at its best you need to replace the brushes as soon as one of the wear indicators is reached (even if the blade wear is not even). It is recommended that you replace the brushes when the rubber is worn down to the top of the wear indicator (or every two years, whichever comes first).

To replace a worn brush:

1. Lift the cleaner to a vertical position so that the handle is up (Figure 26).

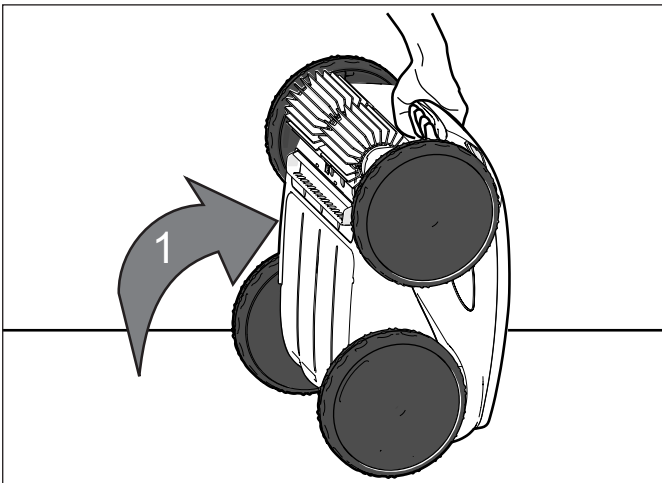

Figure 26. Place Cleaner in Upright Position

2. Separate the edges of the brush and undo the tabs. Remove the worn brushes.

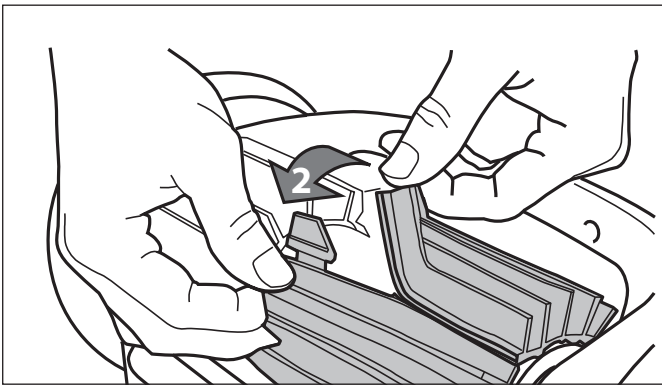

Figure 27. Undo the Tabs of the Brush

3. To install the new brush, position the new brush on the roller with the cleaning blades facing away from the roller.

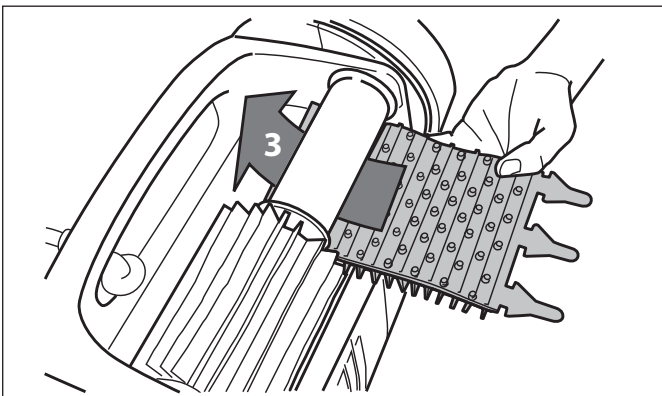

Figure 28. Install the New Brush

4. Thread each tab into the slot provided and gently feed it through until the heel comes out at the other side of the slot.

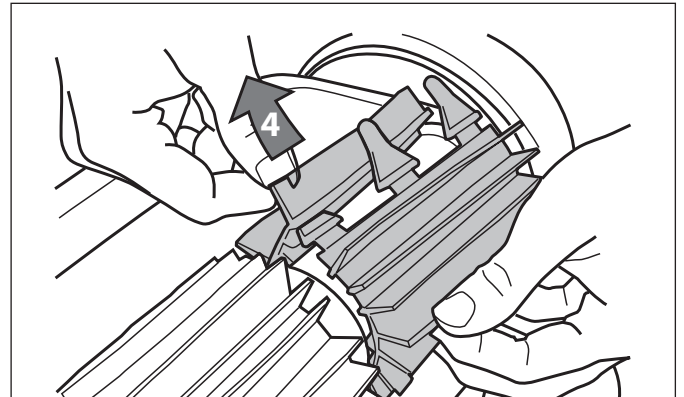

Figure 29. Pull Tabs Through Each Slot

5. Use a pair of scissors to cut the tabs 3/4 inch from the heel so that they are no higher than the cleaning blade.
6. Repeat the procedure to install the second brush.

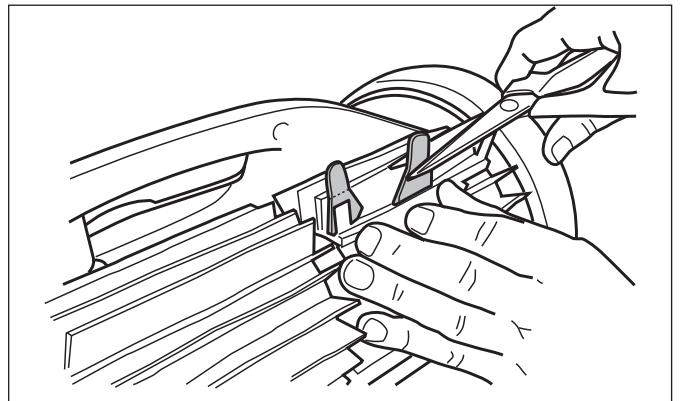

Figure 30. Cut Tabs

7.5 Replacing Tyres

1. Pull on the inside of the old tyre to remove the tire lip from the wheel

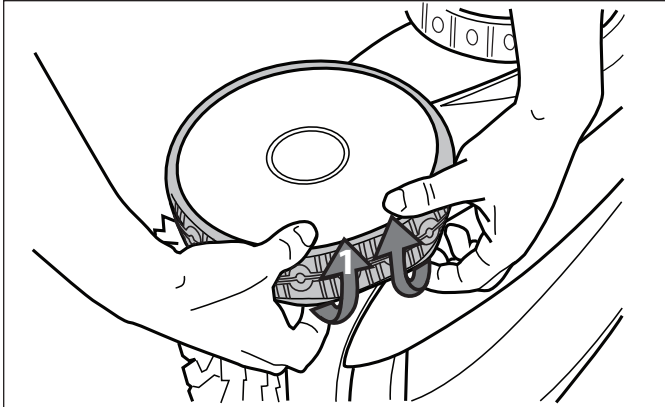

Figure 31. Pull the Old Tyre Over the Wheel

2. Remove the old tyre.

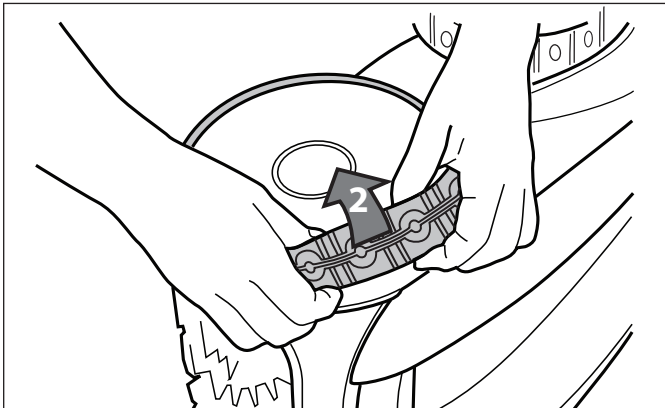

Figure 32. Remove the Old Tyre

3. To replace the tyre, position the tyre on the wheel making sure to orient the tyre so that the word **INSIDE** is toward the body of the cleaner.

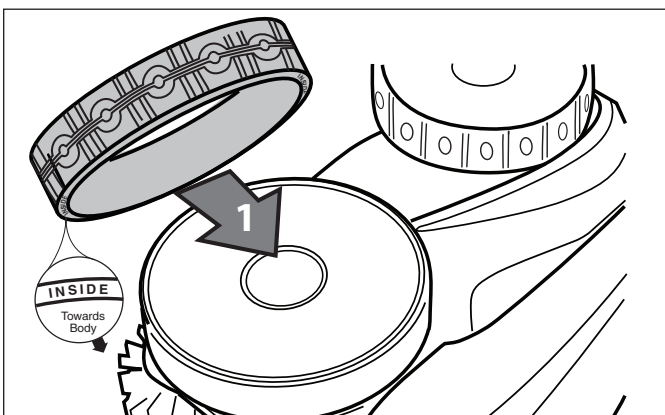

Figure 33. Tyre Replacement Orientation

4. Push one side of the tyre on to the wheel and fit the rib of the tyre in the groove of the wheel.

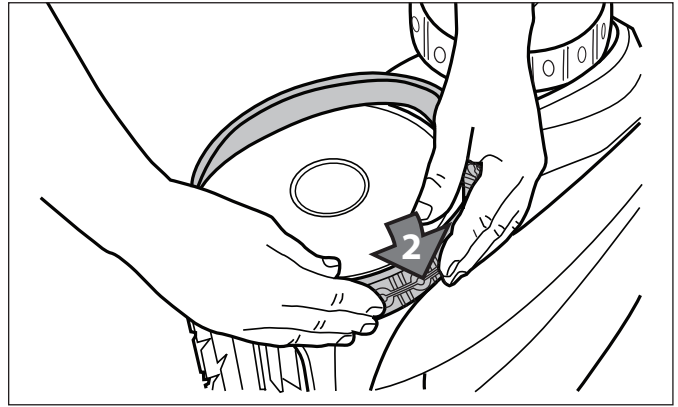

Figure 34. Start on One Side of the Tyre

5. Work the tyre onto the wheel and verify the rib of the tyre is positioned properly within the groove of the wheel.

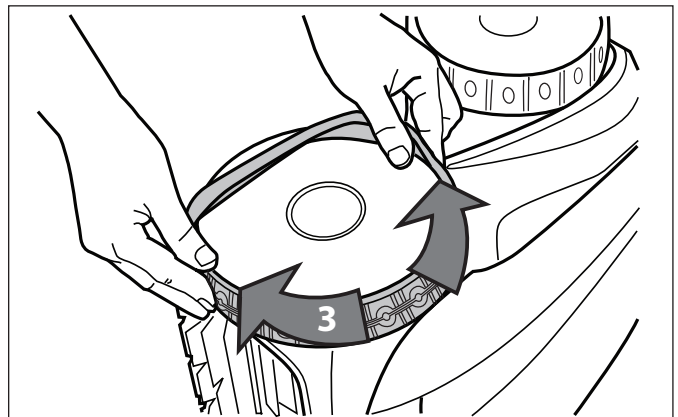

Figure 35. Work the Tyre On Around the Wheel

6. Push and position the rib of the inner side of the tyre in the groove of the wheel. If needed, turn the wheel gently to help with installation.

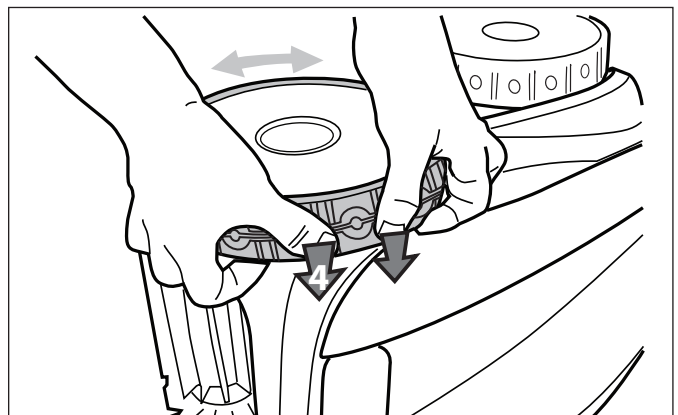

Figure 36. Push the Tyre into Place on the Wheel

7.6 General Troubleshooting

The following list provides some helpful hints for troubleshooting common challenges when using the cleaner.

Message	Possible Cause	Solution
Lights on control unit flash after pressing Start/Stop	Floating cable not connected	Unplug and then reconnect the floating cable to the control unit.
	Cleaner not fully submerged.	Remove cleaner from pool and re-submerge. (see: <i>Install and Submerge the Cleaner</i>).
	Poor connection or need to restart cycle.	Unplug the control unit and reconnect to an approved power outlet. Press "Start" to begin a new cycle.
	Propeller or wheels may be jammed and not turning correctly.	Contact your local retailer to request a diagnostic review. If the problem is not resolved, contact AstralPool Consumer Care 1300 186 875.
The flashing lights appear on the control unit during the cleaning cycle.	Cleaner not fully submerged	Remove cleaner from pool and re-submerge. (see: <i>Install and Submerge the Cleaner</i>).
The cleaner does not stay on the pool surface or is floating excessively.	There is air trapped inside the cleaner housing.	Remove cleaner from pool and re-submerge. (see: <i>Install and Submerge the Cleaner</i>).
	The filter canister is full or dirty.	Dispose of debris and thoroughly clean the filter canister with mild soap and a soft brush. Then, re-submerge the cleaner (see: <i>Clean the Filter Canister</i>).
The cleaner is not climbing walls.	The filter canister is full or dirty.	Dispose of debris and thoroughly clean the filter canister with mild soap and a soft brush. Then, re-submerge the cleaner (see: <i>Clean the Filter Canister</i>).
	Tyre treads worn down	See: <i>Replacing Wear Parts</i>
	Confirm appropriate pool chemistry	Speak with your pool service professional. Do not leave cleaner in the pool during any chemical treatments.
The cleaner is not moving	Not connected to electricity.	The outlet the control unit is connected to, is not supplying electrical power. Check that the outlet to which the control unit is connected is receiving electricity.
	Cycle not started.	Press the Start button to initiate a cleaning cycle.
	Reset needed	Disconnect the unit power and reconnect after 20 seconds. If the problem is not resolved, contact your local retailer to request a diagnostic review or contact AstralPool Consumer Care 1300 186 875.
The floating cable has excessive tangling	Too much cable in the water.	Place only the required amount of cable into the water to allow it to reach the farthest end of your pool with remaining cable on the pool deck. (See: <i>Install and Submerge the Cleaner</i>)
	Removal needed	Untangle the twisted cord and lay in sun to reduce memory. (See: <i>Cord Tangling</i>).

Message	Possible Cause	Solution
The cleaner is not cleaning the pool effectively.	Filter canister is full or dirty.	Dispose of debris and thoroughly clean the filter canister with mild soap and a soft brush. Then, re-submerge the cleaner (see: <i>Clean the Filter Canister</i>).
	Brushes are worn.	Check the wear indicator(s). Contact your local dealer for spare parts.
	Cable is excessively tangled.	Untangle the twisted cord and lay in sun to reduce memory. (See: <i>Cord Tangling</i>).

7.7 Dismissing an Error Code

From the Control Unit:

After you have completed the troubleshooting solution steps, press any key (except the phone icon) to clear the error code.

If the control unit is in Standby Mode, press the Start/Stop button to show the on-screen display. After you have completed the troubleshooting solution steps, press any key (except the phone icon) to clear the error code.

From the iAquaLink™ App:

Press the error icon to display troubleshooting solutions. After you have completed the troubleshooting solution steps, press **Clear Error** to return to normal operation. Or, press **OK** if you need to complete the solution steps at a later time.

7.8 iAquaLink™ Troubleshooting

This information can help to troubleshoot connection and setup challenges between the iAquaLink app and the cleaner.

How It Works

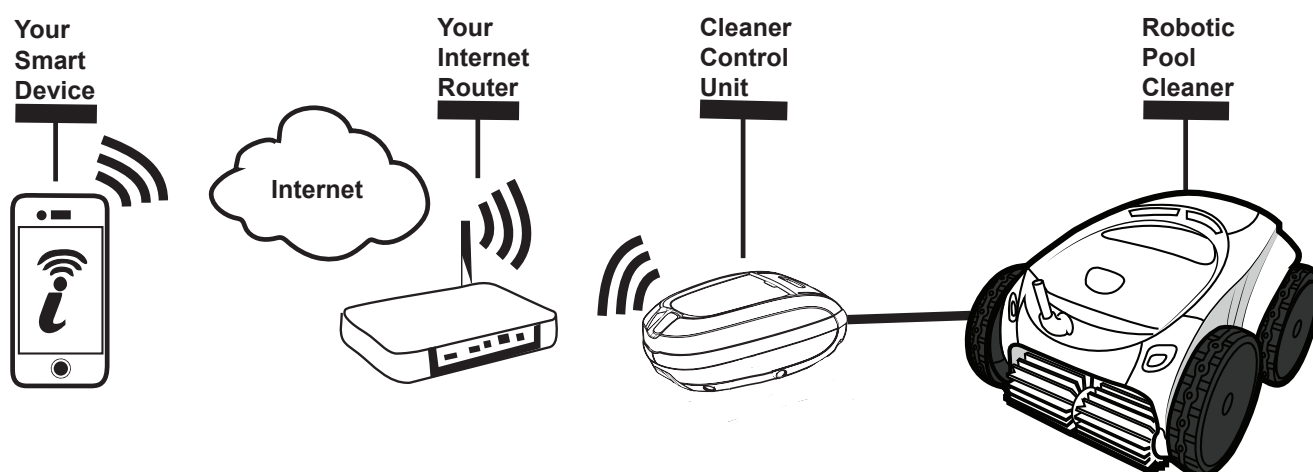

How to connect:

You must connect to the home router (network) by first establishing a direct connection between the control box and your smart device. (See: *Configuring the System*.)

IMPORTANT: It is recommended to locate the control box as close to the home router as practical. Do not use an extension cord.

Common iAquaLink™ Troubleshooting

Remember, if you get a new Wi-Fi Router, reset the defaults of your current Wi-Fi Router or simply change your Wi-Fi network password, you will have to re-establish the connection between your cleaner and the router. (See: *Configure the System*.)

User Issue	Possible Cause	Solution
All lights are off	Bright sunlight	Shield the lights to block sunlight and re-check if the lights are lit.
	Control box is unplugged.	Plug the control unit in. (See: <i>Connect to a Power Source</i>).
	Power outage.	Verify that the breaker is on and electricity is being supplied to the outlet.
	Lost internet connection.	Check internet connection - Network may be down.
Wi-Fi is off	Router is off.	Turn router on.
	Router password was changed.	Reset router with new password.
Wi-Fi light is flashing	Lost internet connection	Check internet connection - Network may be down.
	Control box is too far from home router	Relocate the control box as near to the home router as practical. (See: <i>Install and Submerge the Cleaner</i>) Do not use an extension cord.
	Weak Wi-Fi signal	<ul style="list-style-type: none"> Check for adequate Wi-Fi signal strength. With a Windows laptop, go to Network Connections in the Control Panel. Check Signal Strength meter under Wireless Network Connection icon while standing near the control box. With a smart device, search for, download, and use an app that can check signal strength while standing near the control box. If Wi-Fi signal is weak, consider installing a Wi-Fi extender.
	Connectivity issue with local Wi-Fi or connection to the server.	Contact your local internet service provider. <ul style="list-style-type: none"> Unplug your control box and wait 10 seconds. Plug in the box again and see if lights illuminate. Check Internet connection - Network may be down.
	Antenna firmware update in progress.	Flashing may continue up to ten minutes until update is complete.

7.9 Conformity



The manufacturer reserves the right to modify these specifications without notice. Although the cleaning robots have been tested in a large variety of swimming pools, AstralPool cannot be held responsible in the case of a non-perfect adaptation of the robot to a particular swimming pool.

NOTES



For full warranty terms and conditions and to register your warranty, visit www.astralpool.com.au/warranty and complete your details. Or scan the QR code to go directly to the registration page

Record your cleaner details here for quick reference:

Model No. : _____

Serial No. : _____

Date of Purchase : _____

Purchased From: _____

City: _____

State: _____ Post Code: _____

Fluidra Group Australia Pty Ltd

219 Woodpark Road

Smithfield NSW 2164, Australia

PO Box 7238 Wetherill Park NSW 1851, Australia

1300 186 875

www.astralpool.com.au

©2019 Fluidra S.A. All rights reserved. This document is subject to change without notice.